

UNIVERSAL BAIL ARMS

- Tilt and swivel carry handle bars/bail arms made of diecast zinc
- With matching aluminum profile, cut to the correct width for your enclosure, and supplied as a separate component.

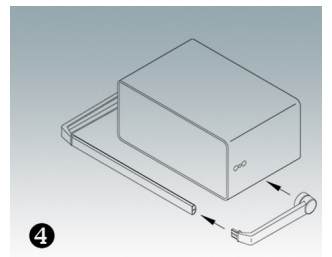

Select Versions

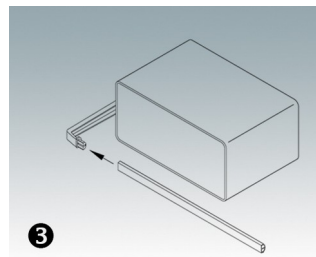
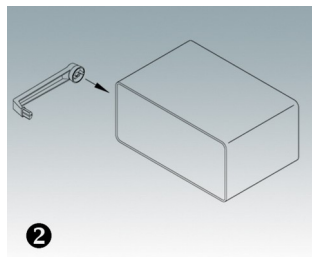
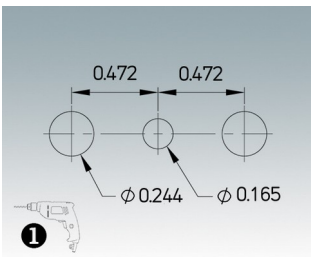
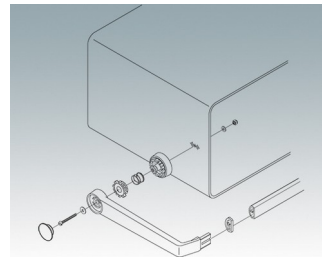
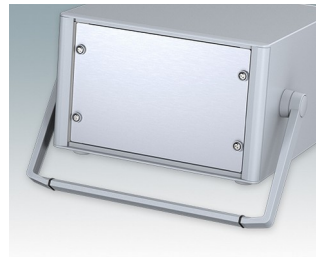
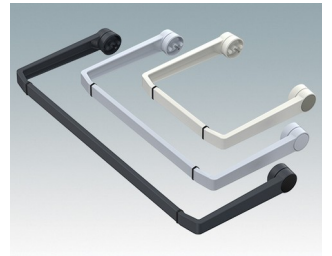
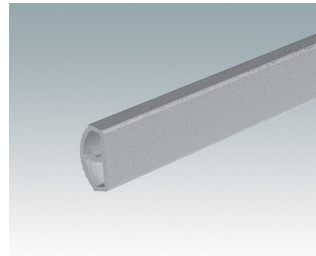
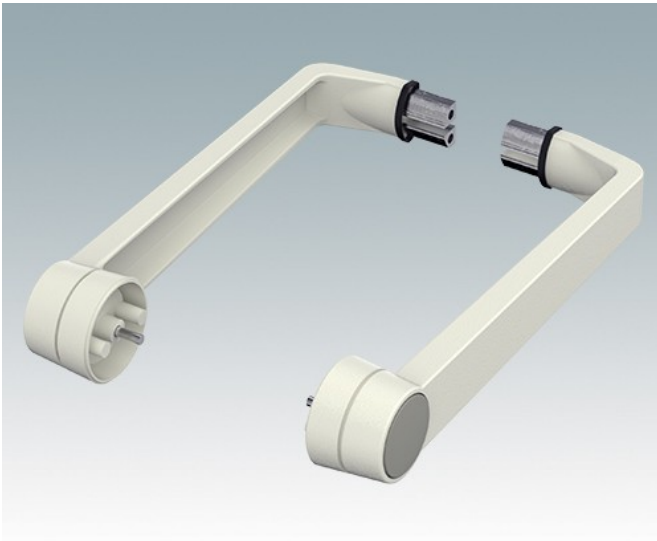
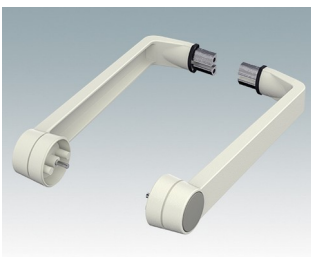

A9300014
Side arm kit
Zinc
Off-white RAL 9002

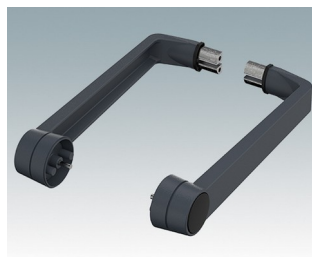

M5093004
Side arm kit
Zinc
Anthracite RAL 7016

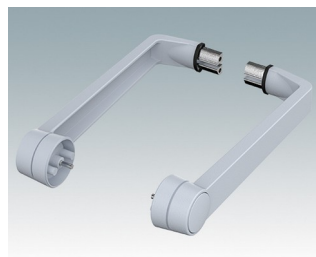

M5093005
Side arm kit
Zinc
Light gray RAL 7035

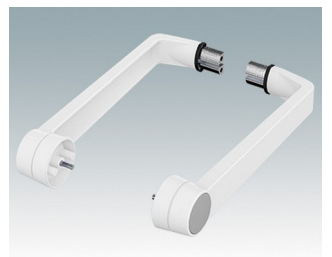

M5093006
Side arm kit
Zinc
Traffic white RAL 9016



M5093009
Side arm kit
Zinc
Black RAL 9005

System components to complete

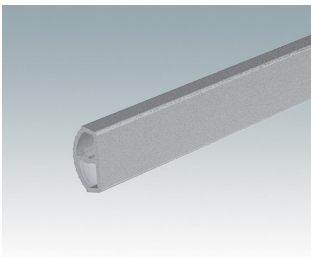

M50930-xxx
Handle profile, RAL 9006
Aluminum
Silver metallic RAL 9006

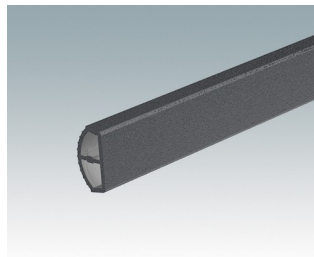

M50934-xxx
Handle profile, RAL 7016
Aluminum
Anthracite RAL 7016

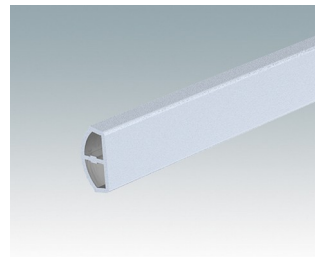

M50935-xxx
Handle profile, RAL 7035
Aluminum
Light gray RAL 7035

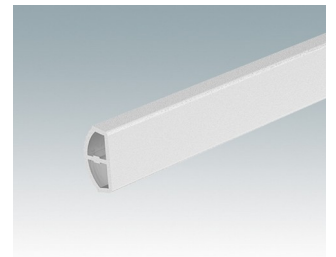

M50936-xxx
Handle profile, RAL 9016
Aluminum
Traffic white RAL 9016

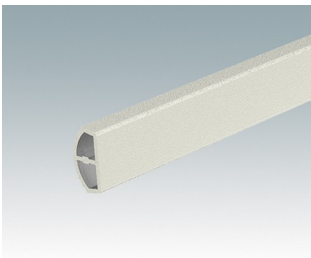

M50937-xxx
Handle profile, RAL 9002
Aluminum
Off-white RAL 9002

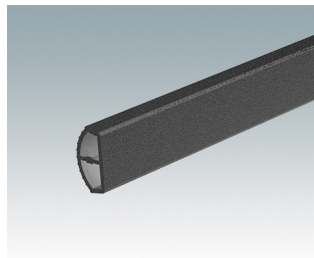

M50939-xxx
Handle profile, RAL 9005
Aluminum
Black RAL 9005

Subject to technical modification without notice. © OKW Enclosures Ltd